

we move your process...



...for over 20 years



Management
System
ISO 9001:2015

www.tuv.com
ID 900004269

WWTec GmbH & Co. KG – Solutions for your process

Junior Cube System

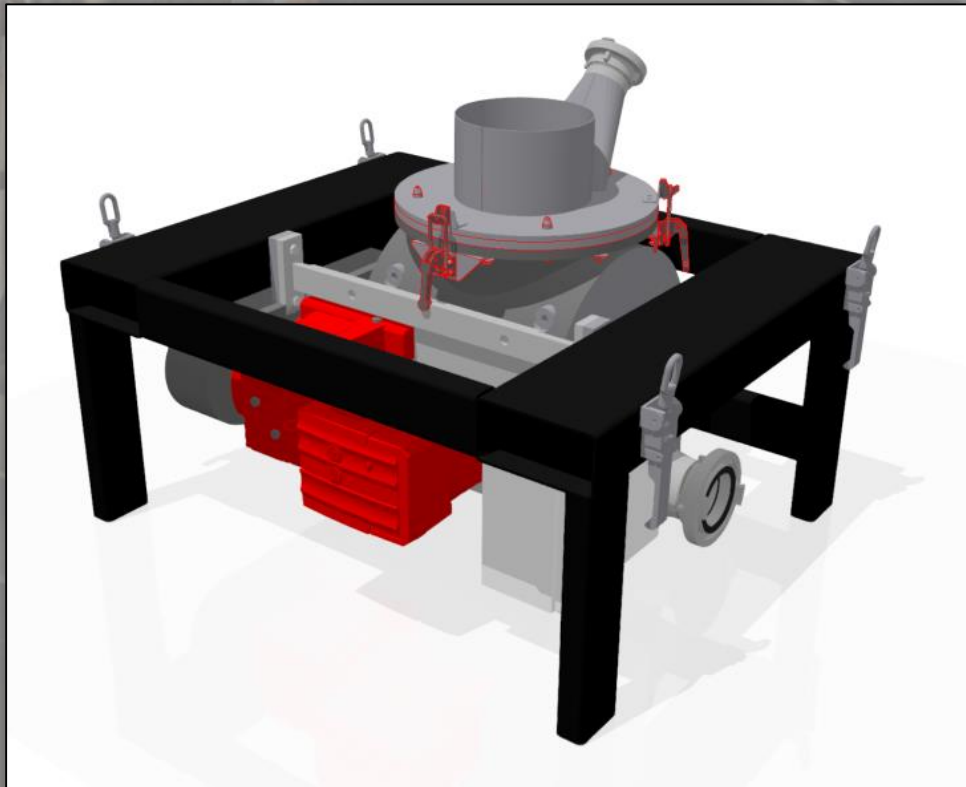
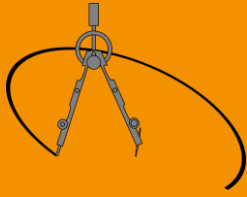

- ❖ **Reliable container unloading system for granules and free-flowing bulk**
- ❖ **Transfer of the material either into vertical silos or directly into the production**
- ❖ **Ready for operation any time and anywhere due to mountings for fork-lift**

WWTec GmbH & Co. KG – Solutions for your process

Junior Cube System

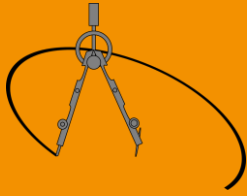

Container-unloading: easy, safe and mobile



Variants from the WWTec sandbox system

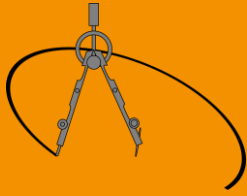

Junior Cube System

Bag Emptying Station

safe and easy loading

Proven and robust technique

mobile and efficient bulk loading

suitable nearly for all free-flowing kinds of bulk



WWTec Bag Emptying Station

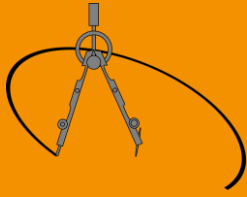

- ❖ **Advanced design of the CQF - junior**
- ❖ **Reliable combination system for the manual emptying of sacks or BigBags containing free-flowing bulk**
- ❖ **Transfer of the material either into vertical silo arrangements or directly into the production**
- ❖ **Ready for operation any time and anywhere due to mountings for fork-lift**

WWTec GmbH & Co. KG – Solutions for your process

WWTec Bag Emptying Station

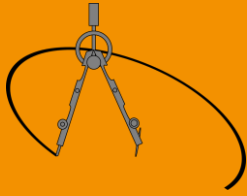

Combination Unit: Junior Cube plus emptying device on top



Variants from the WWTec sandbox system

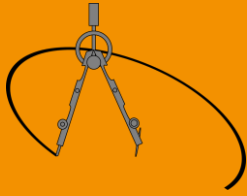

two in one!



Transfer filling station for sacks and for Big Bags with dust collection (based on our Junior Cube)

WWTec GmbH & Co. KG – Solutions for your process

Contact



WWTec GmbH & Co. KG
In den Erlen 8 | D-56206 Hilgert
Tel +49 (0) 2624 94 370 44
Fax +49 (0) 2624 94 370 48
Mobil +49 (0) 151 1083 3000
info@hvdgroup.de
www.hvdgroup.de



Management System
ISO 9001:2015

www.tuv.com
ID 9000004269

24.01.2020

